

N-Channel MOSFET

2KK5115DFN

■ Features

- $V_{DS} (V) = 60 V$
- $I_{DMAX} = 80 A$
- $R_{DS(ON)} < 7.5m\Omega @ V_{GS}=10V$
- $R_{DS(ON)} < 9.5m\Omega @ V_{GS}=4.5V$

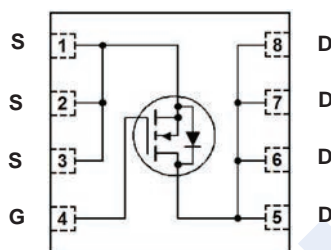

DFN5x6-8

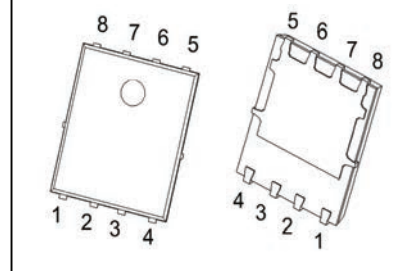
■ Absolute Maximum Ratings ($T_A = 25^\circ C$ unless otherwise noted)

Parameter	Symbol	Rating	Unit	
Drain-Source Voltage	V_{DS}	60	V	
Gate-Source Voltage	V_{GS}	± 20		
Continuous Drain Current	I_D	$T_C=25^\circ C$	80	
		$T_C=100^\circ C$	51	
Continuous Drain Current	I_D	$T_A=25^\circ C$	10	
		$T_A=100^\circ C$	8	
Pulsed Drain Current (Note 1)	I_{DM}	200	A	
Diode Continuous Forward Current	I_S	25		
Avalanche Current, Single pulse ($L=0.5mH$) (Note 2)	I_{AS}	20		
Avalanche Energy, Single pulse ($L=0.5mH$) (Note 2)	E_{AS}	100		mJ
Power Dissipation	P_D	$T_C=25^\circ C$		52
		$T_C=100^\circ C$		20.8
Power Dissipation	P_D	$T_A=25^\circ C$		2
		$T_A=100^\circ C$	1.3	
Thermal Resistance.Junction- to-Case	Steady State	$R_{\theta JC}$	2.4	
Thermal Resistance.Junction- to-Ambient (Note 3)	$t \leq 10s$	$R_{\theta JA}$	25	
	Steady State		60	
Junction Temperature	T_J	150	$^\circ C$	
Storage Temperature Range	T_{stg}	-55 to 150		

Notes 1. Pulse width limited by max. junction temperature.

2. UIS tested and pulse width limited by maximum junction temperature $150^\circ C$ (initial temperature $T_J=25^\circ C$).

3. Surface Mounted on $1in^2$ pad area.

N-Channel MOSFET

2KK5115DFN

■ Electrical Characteristics ($T_A = 25^\circ\text{C}$ unless otherwise specified)

Parameter	Symbol	Test Conditions	Min	Typ	Max	Unit
Drain-Source Breakdown Voltage	BV_{DSS}	$I_D = 250\ \mu\text{A}$, $V_{GS} = 0\text{V}$	60			V
Zero Gate Voltage Drain Current	I_{DSS}	$V_{DS} = 48\text{V}$, $V_{GS} = 0\text{V}$			1	μA
		$V_{DS} = 48\text{V}$, $V_{GS} = 0\text{V}$, $T_J = 85^\circ\text{C}$			30	
Gate to Source Leakage Current	I_{GSS}	$V_{DS} = 0\text{V}$, $V_{GS} = \pm 20\text{V}$			± 100	nA
Gate to Source Threshold Voltage	$V_{GS(th)}$	$V_{DS} = V_{GS}$, $I_D = 250\ \mu\text{A}$	1.1		2.1	V
Static Drain-Source On-Resistance (Note 4)	$R_{DS(on)}$	$V_{GS} = 10\text{V}$, $I_D = 25\text{A}$			7.5	m Ω
		$V_{GS} = 4.5\text{V}$, $I_D = 25\text{A}$			9.5	
Input Capacitance	C_{iss}	$V_{GS} = 0\text{V}$, $V_{DS} = 30\text{V}$, $f = 1\text{MHz}$		2500	3500	pF
Output Capacitance	C_{oss}			215		
Reverse Transfer Capacitance	C_{rss}			105		
Gate Resistance	R_g	$V_{GS} = 0\text{V}$, $V_{DS} = 0\text{V}$, $f = 1\text{MHz}$		1		Ω
Total Gate Charge	Q_g	$V_{GS} = 10\text{V}$, $V_{DS} = 30\text{V}$, $I_{DS} = 25\text{A}$		45	65	nC
Gate Source Charge	Q_{gs}			9		
Gate Drain Charge	Q_{gd}			8.5		
Turn-On Delay Time	$t_{d(on)}$	$V_{DD} = 30\text{V}$, $R_L = 30\ \Omega$, $I_{DS} = 1\text{A}$, $V_{GEN} = 10\text{V}$, $R_G = 6\ \Omega$		20	36	ns
Turn-On Rise Time	t_r			9	16	
Turn-Off Delay Time	$t_{d(off)}$			55	99	
Turn-Off Fall Time	t_f			20	36	
Body Diode Reverse Recovery Time	t_{rr}	$I_F = 25\text{A}$, $di/dt = 100\text{A}/\mu\text{s}$		28		nA
Body Diode Reverse Recovery Charge	Q_{rr}			30		
Diode Forward Voltage (Note 4)	V_{SD}	$I_{SD} = 25\text{A}$, $V_{GS} = 0\text{V}$			1.3	V

Notes 4: Pulse test ; pulse width $\leq 300\ \mu\text{s}$, duty cycle $\leq 2\%$.

■ Marking

Marking	K5115 K****
---------	----------------

N-Channel MOSFET

2KK5115DFN

■ Typical Characteristics

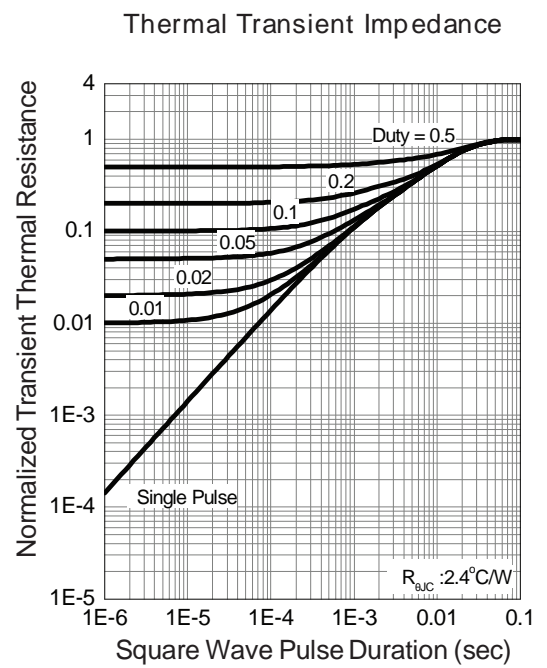
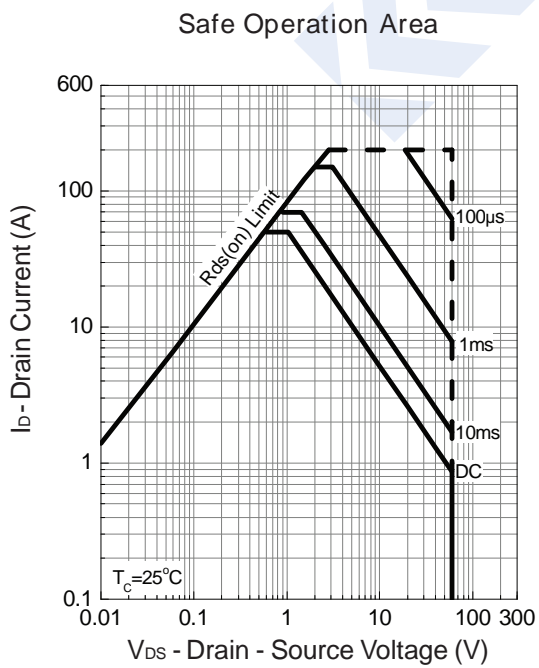
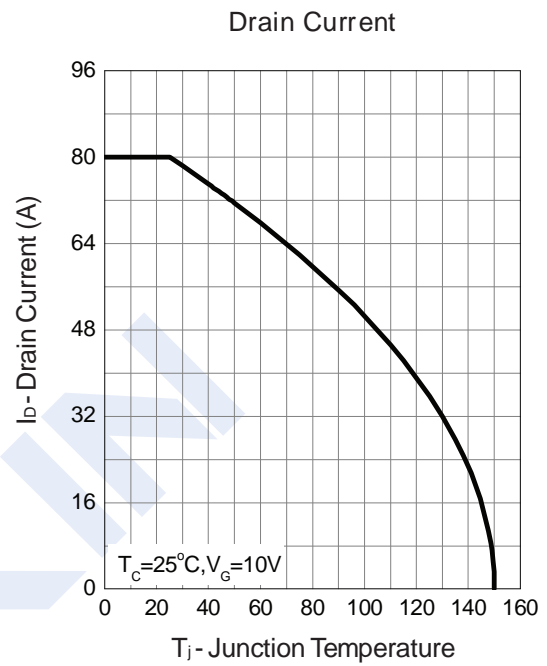
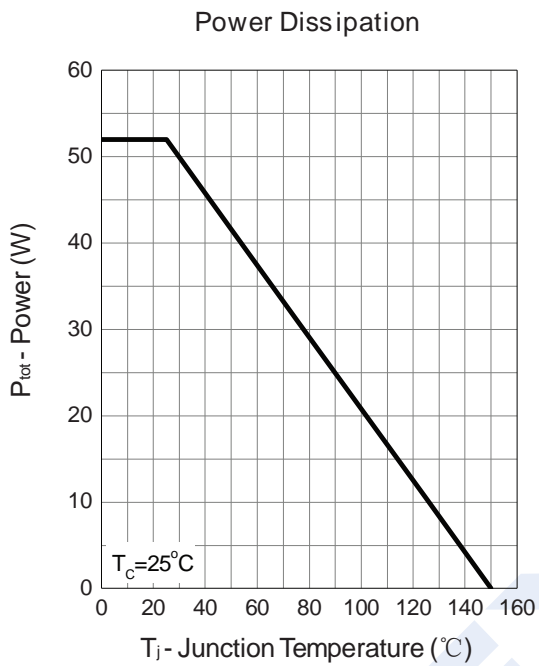

N-Channel MOSFET

2KK5115DFN

Output Characteristics

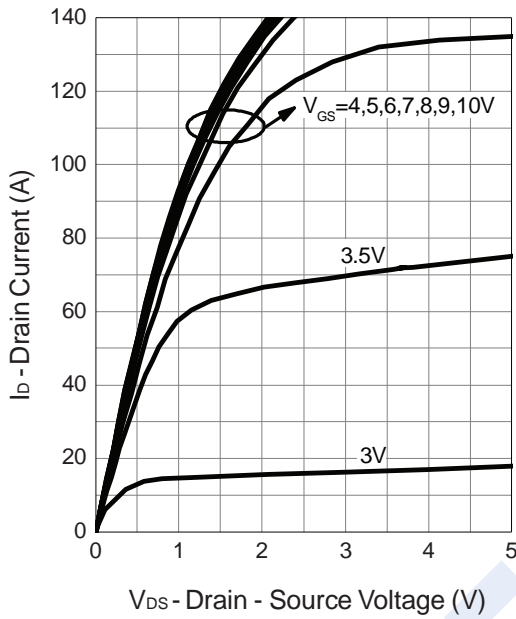

Drain-Source On Resistance

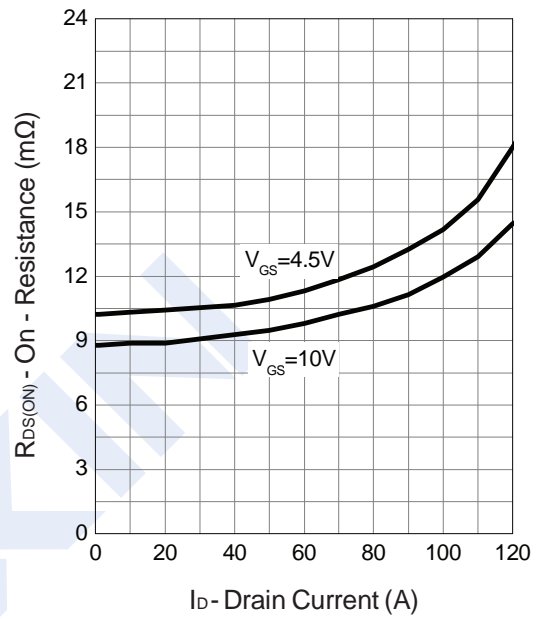

Gate-Source On Resistance

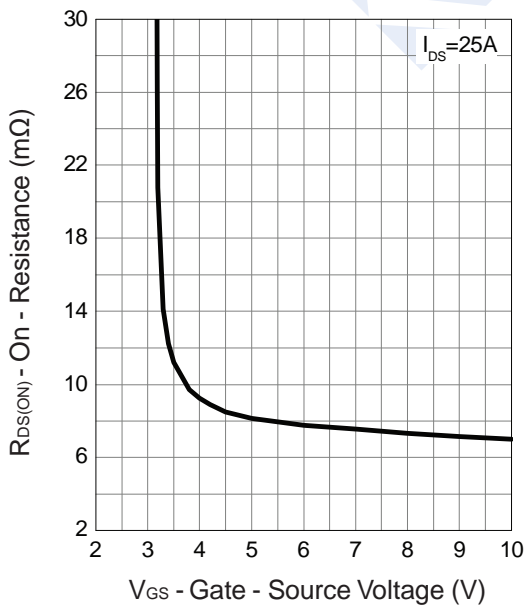

Gate Threshold Voltage

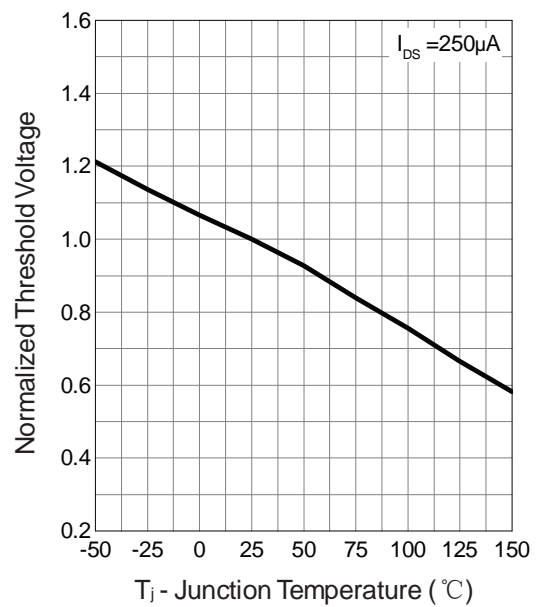

N-Channel MOSFET

2KK5115DFN

Drain-Source On Resistance

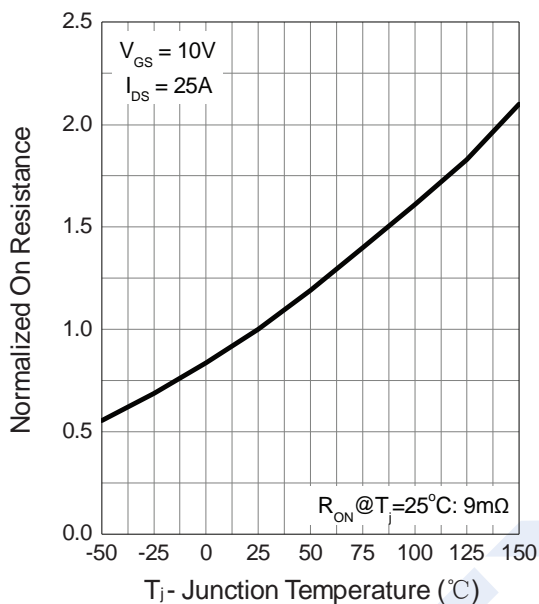

Source-Drain Diode Forward

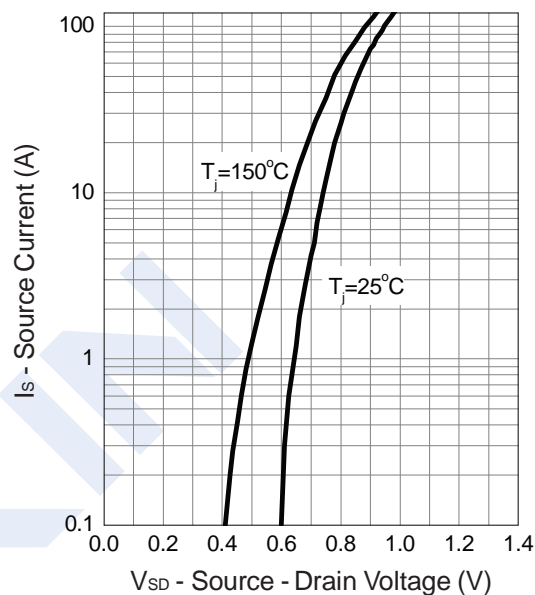

Capacitance

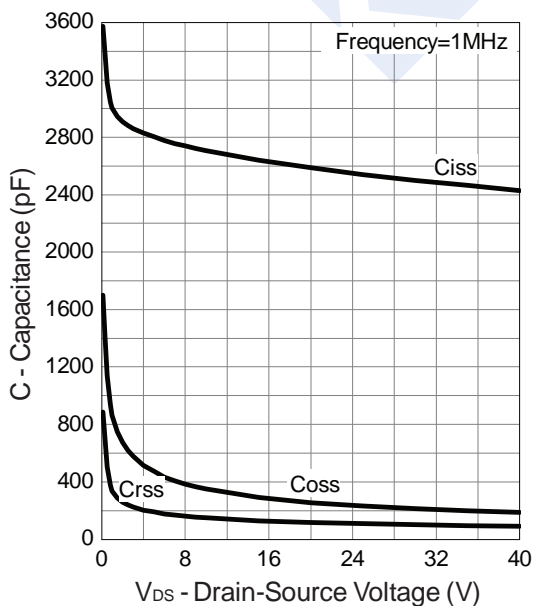

Gate Charge

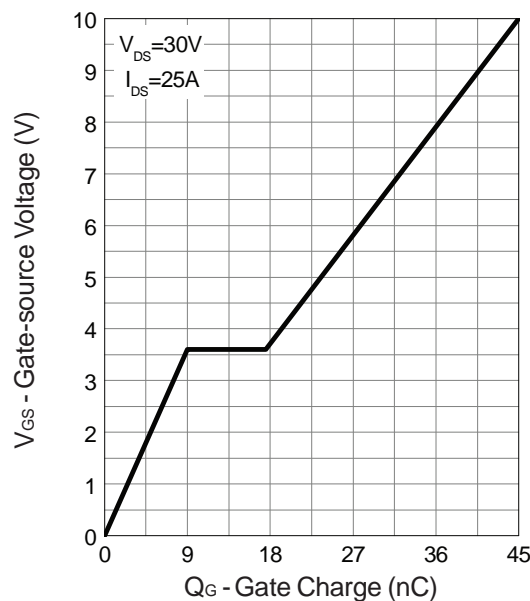

N-Channel MOSFET

2KK5115DFN

■ Avalanche Test Circuit and Waveforms

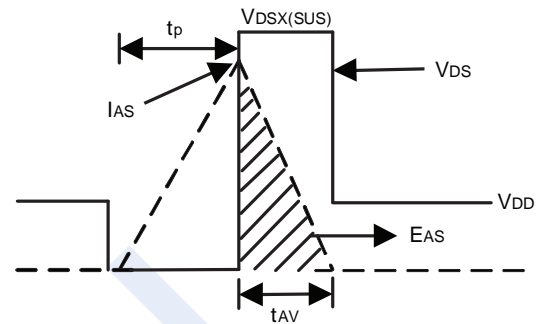
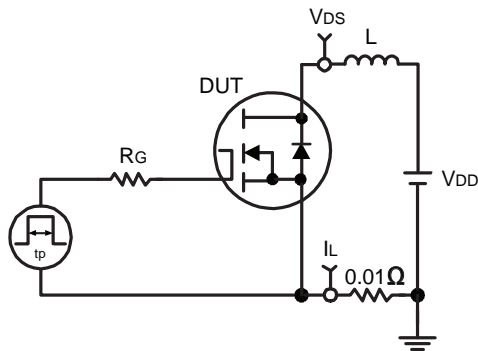

■ Switching Time Test Circuit and Waveforms

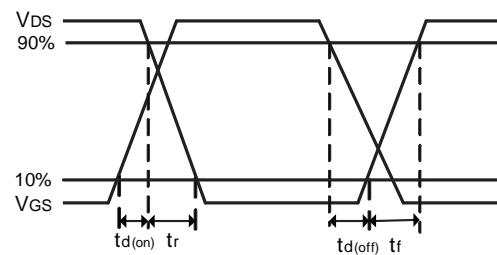
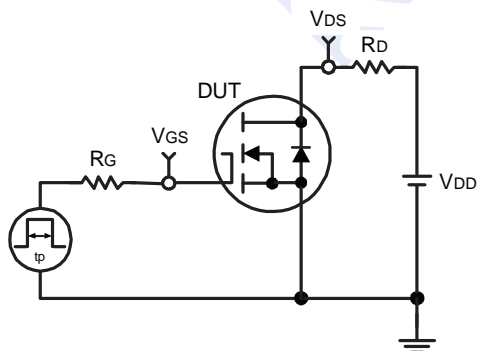

N-Channel MOSFET

2KK5115DFN

PDFN5x6-8 Package Outline Dimensions

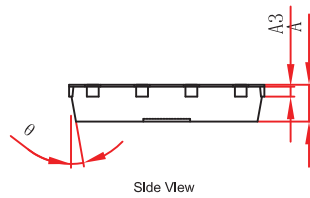
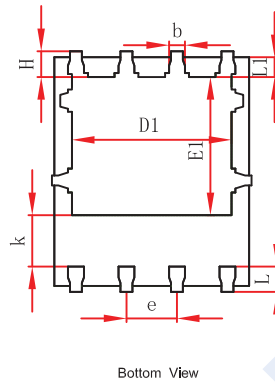
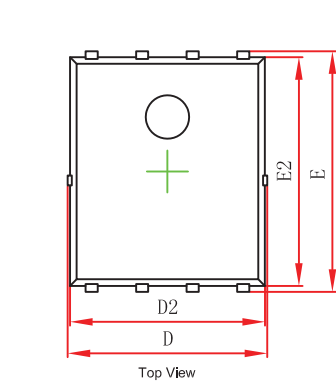

Symbol	Dimensions In Millimeters		Dimensions In Inches	
	Min.	Max.	Min.	Max.
A	0.900	1.000	0.035	0.039
A3	0.254REF.		0.010REF.	
D	4.944	5.096	0.195	0.201
E	5.974	6.126	0.235	0.241
D1	3.910	4.110	0.154	0.162
E1	3.375	3.575	0.133	0.141
D2	4.824	4.976	0.190	0.196
E2	5.674	5.826	0.223	0.229
k	1.190	1.390	0.047	0.055
b	0.350	0.450	0.014	0.018
e	1.270TYP.		0.050TYP.	
L	0.559	0.711	0.022	0.028
L1	0.424	0.576	0.017	0.023
H	0.574	0.726	0.023	0.029
θ	10°	12°	10°	12°

PDFN5x6-8 Suggested Pad Layout

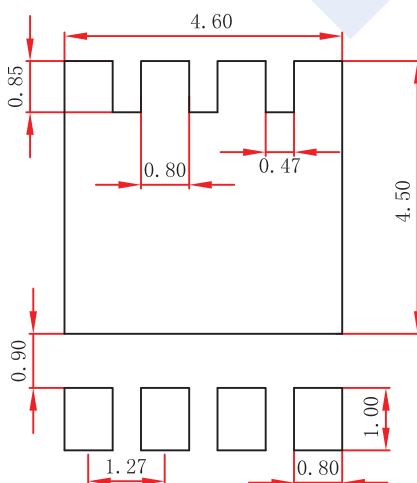

- Note:
1. Controlling dimension: in millimeters.
 2. General tolerance: $\pm 0.05\text{mm}$.
 3. The pad layout is for reference purposes only.